

Model No. GA9020R 230MM ANGLE GRINDER

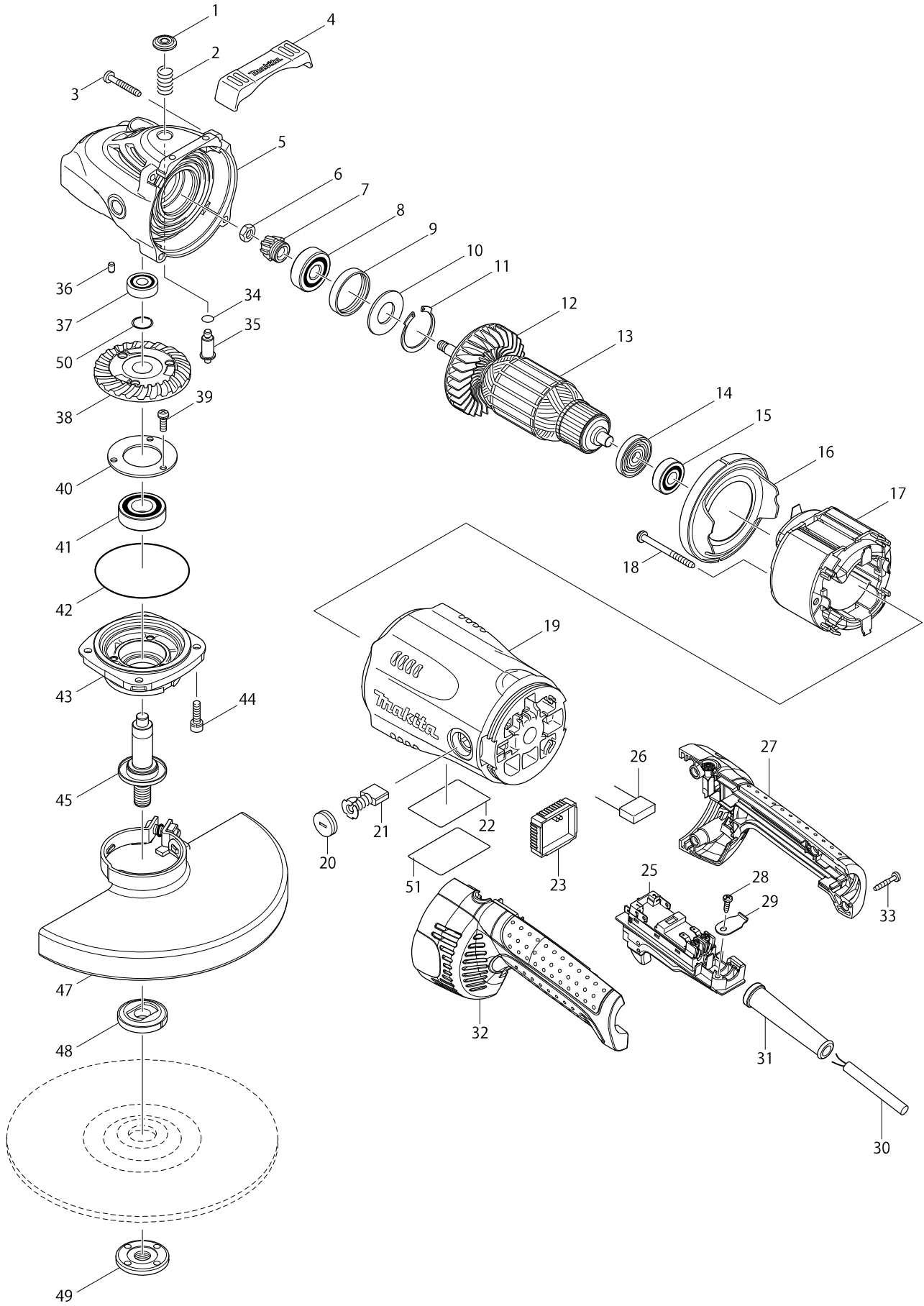

Model No. GA9020R 230MM ANGLE GRINDER

Item	Parts No.	Description	I/C	Qty	N/O	Opt. 1	Opt. 2	Note
001	419133-4	PIN CAP		1				
002	233292-8	COMPRESSION SPRING 12		1				
003-1	266012-5	TAPPING SCREW 5X35		4				
004	419144-9	BUMPER		1				
005	154685-5	GEAR HOUSING COMPLETE		1	*			
C10	262118-7	FELT RING 18		1	*			
005-1	142754-4	GEAR HOUSING COMPLETE	<	1				
C10	262118-7	FELT RING 18		1				
006	252194-9	HEX. NUT M8		1				
007	227490-4	SPIRAL BEVEL GEAR 12		1				
008	211132-0	BALL BEARING 6301DDW		1				
009	262085-6	RUBBER RING 38		1				
010	267299-2	FLAT WASHER 20		1				
011	962211-4	RETAINING RING R-42		1				
012	240081-4	FAN 80		1				
013	510125-7	ARMATURE ASS'Y 220V		1				
D10		INC. 12,14,15						
014	681630-2	INSULATION WASHER		1				
015	211087-9	BALL BEARING 6200DDW		1				
016	419135-0	BAFFLE PLATE		1				
017	526214-8	FIELD ASSEMBLY 240V		1				
C10	654197-3	RING TERMINAL		2				
C20	654502-4	CONNECTOR P-2		2				
018-1	266044-2	TAPPING SCREW 5X60		2				
019	154671-6	MOTOR HOUSING COMPLETE		1				
C10	643712-8	BRUSH HOLDER		2				
020	643700-5	BRUSH HOLDER CAP 7-18		2				
021	191957-7	A.C. CARBON BRUSH CB-204		1				
022	867513-2	GA9020R NAME PLATE		1				
023	631944-9	CONTROLLER		1				
025	650107-8	SWITCH TG08-2300-013		1				
026	645088-9	NOISE SUPPRESSOR		1				
027	188844-9	HANDLE SET		1				
C10	423404-3	SPONGE SHEET		1				
C20	451488-1	LENZ		1				
D10		INC. 32						
028-1	266192-7	TAPPING SCREW 4X14		1				
029	687169-3	STRAIN RELIEF		1				
030	695107-1	POWER SUPPLY CORD 1.5-2-2.5		1				
031	682560-0	CORD GUARD 10		1				
032	188844-9	HANDLE SET		1				
C10	423404-3	SPONGE SHEET		1				
C20	451488-1	LENZ		1				
D10		INC. 27						
033-1	265999-8	TAPPING SCREW 4X25		4				
034	213062-1	O RING 9		1				
035	256491-5	SHOULDER PIN 5		1				
036	263002-9	RUBBER PIN 4		1				

